



External Transmission Oil Cooler Kit

Suitable for:

Any vehicle that has transmission
cooler hoses with an internal diameter
of:
3/8" (9.5mm) OR
5/16" (8mm)

Please read through all of the instructions carefully before proceeding. If any of the information does not appear correct or the diagrams don't match your vehicle, please contact Wholesale Automatic Transmissions on +61 3 9762 8004.

Parts List



1 x Dual Cooler Bracket with Coolers

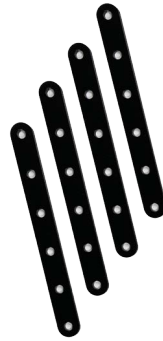

4 x Bendable Mounting Straps



2.5m x Cooler Line Hose with Protective Conduit



6 x 8-16 Stainless Steel Hose Clamps



1 x Dual Cooler Link Hose (0.45m)



4 x M6x20 SEMS Bolts



4 x M6 Flange Nuts



5 x Cable Ties

Expected Installation Time: 2~3 Hours

Summary of Installation - For Experienced Fitters

- SAFETY FIRST: Allow engine, transmission and transmission fluid to cool prior to starting work to prevent serious injury.
- Remove any shrouds to gain access to area behind grill.
- Remove any bash plates blocking access to underneath radiator.
- Find suitable location to mount the cooler assembly.
- Test fit cooler assembly to find the best location/orientation.
- Fit Dual Cooler Link hose between each cooler with hose clamps. Coolers are bi-directional. Choose the connections that best fit the space in the vehicle.
- Fit Cooler Line Hose to remaining connections on each cooler using hose clamps. The coolers are bi-directional. Choose connections that best fit the space.
- Fit/cut/manipulate the supplied bendable mounting straps to mount cooler in suitable location.
- Bolt the bendable mounting straps to the cooler assembly using supplied M6 SEMS bolts and M6 Flange nuts. Leave loose until you have it in correct location.
- Tighten all bolts to hold bracket firm.
- Find a suitable location to tap into the OEM Cooler lines. Preferable routing of transmission fluid is through OEM radiator/coolers first, then through new coolers.
- Route cooler line hose to tap in location using cable ties to secure away from hot or moving parts on the vehicle.
- Fit hose to OEM connections with hose clamps.
- Check all parts are secure and no loose items can come into contact with hot or moving parts.
- Start vehicle and check transmission fluid level. Top up if required using manufacturers recommended transmission fluid .
- Clean any transmission fluid spilled during installation. Re-install any parts removed.
- Test drive vehicle for at least 10 minutes. Check for leaks and re-check Transmission oil.

Detailed Installation Instructions

1. Cooler Assembly Mounting

Before commencing work, please ensure that you have at least 2L of transmission fluid to top up at the end of the job.

Due to this product being a Universal Dual Cooler kit, there are no specific instructions that we can provide. Instead, we have provided these instructions and photos purely as a guide or as an example of what may be required during the installation on your vehicle.

Also take note that some of the steps may not apply to your specific vehicle.

- 1.1. Open bonnet.
- 1.2. Remove any bash plates preventing access to underneath the radiator.
- 1.3. If present, remove any shrouds or covers preventing access to the area behind the grill or in front of the radiator.
- 1.4. Find suitable location behind the grill to mount the cooler assembly. Test fit cooler assembly to find the best fit / orientation.

We have designed the universal cooler assembly in such a way that you can orient the coolers with the hose fittings in any direction that is needed. Likewise the bracket and the straps can be oriented in any direction needed or use any mounting location on the bracket.



- 1.5. Fit the dual cooler link hose between front and rear cooler using hose clamps. Fit the cooler line hose to the remaining connections using hose clamps.
NOTE: Coolers are bi-directional - choose the connection on each cooler that fits best in the space you have. Below is an example of mounting coolers horizontally with the dual cooler link hose and main cooler hose fitted.

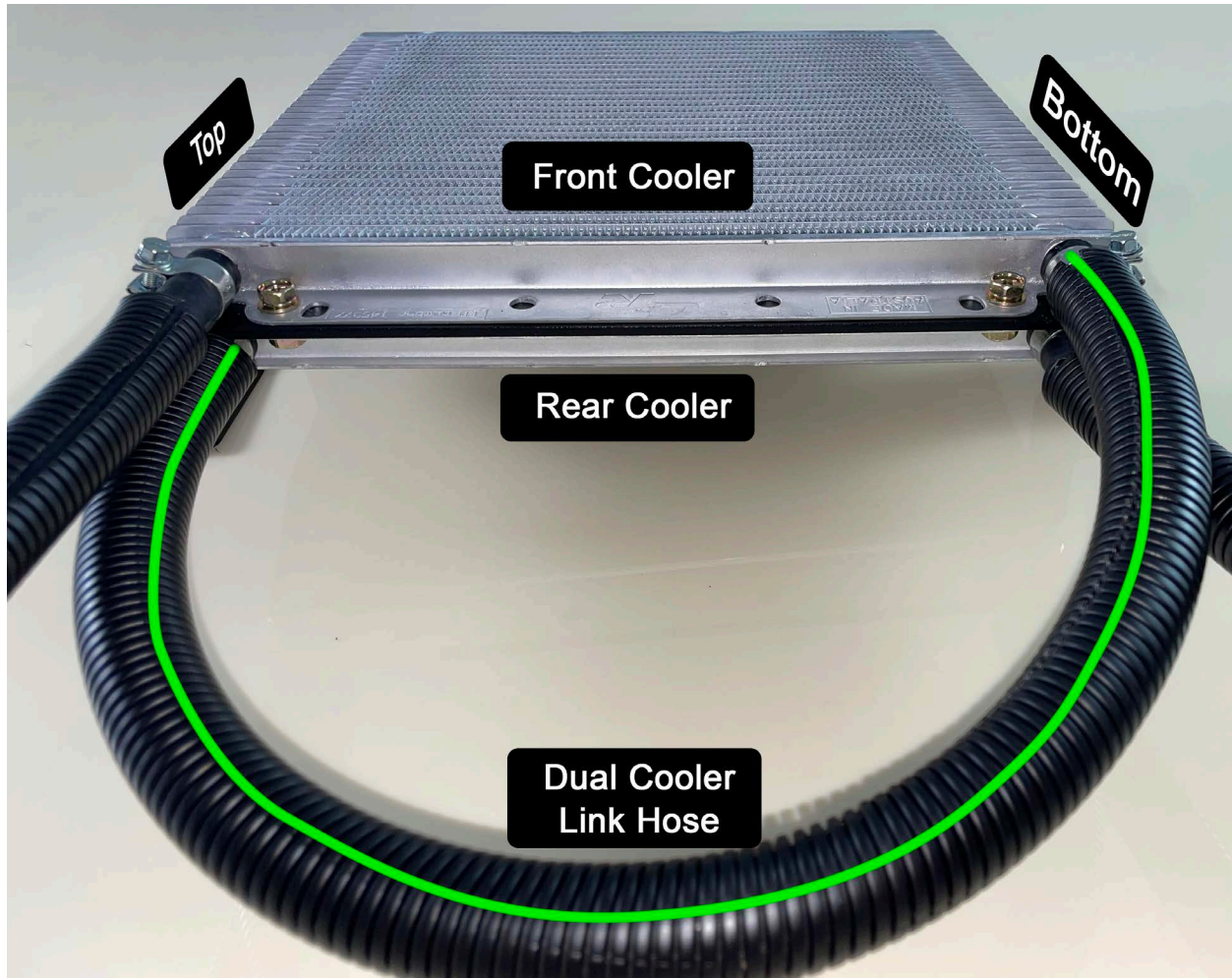

- 1.6. Using the supplied bendable straps - cut, trim and manipulate the straps to mount the cooler bracket to the vehicle. The straps can be bolted to any mounting point on the bracket.
- 1.7. Always choose mounting points that are a part of the body of the vehicle - such as the radiator support panels. Once assembly is in place, tighten all bolts to secure.

DO NOT MOUNT TO THE CHASSIS RAIL OR CROSS-MEMBERS.

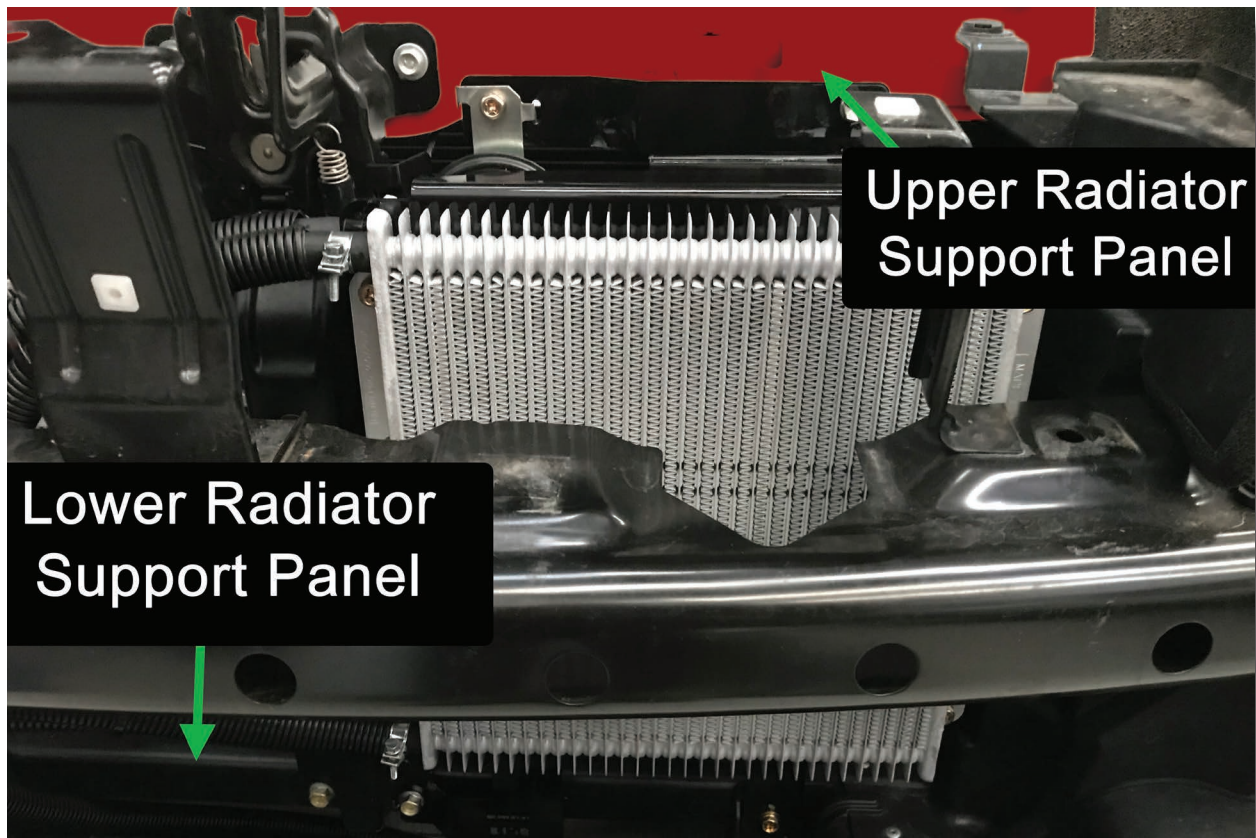

- 1.8. Find a suitable location in the OEM cooler system to tap into the cooler lines. On some vehicles there will be steel lines with rubber hose connections that can be easily removed. This is the best location to connect in the new cooler assembly.

We have seen some vehicles with swaged fittings at the end of the rubber lines, which means you will need to cut the rubber line and fit an appropriate sized joiner to connect the cooler assembly.

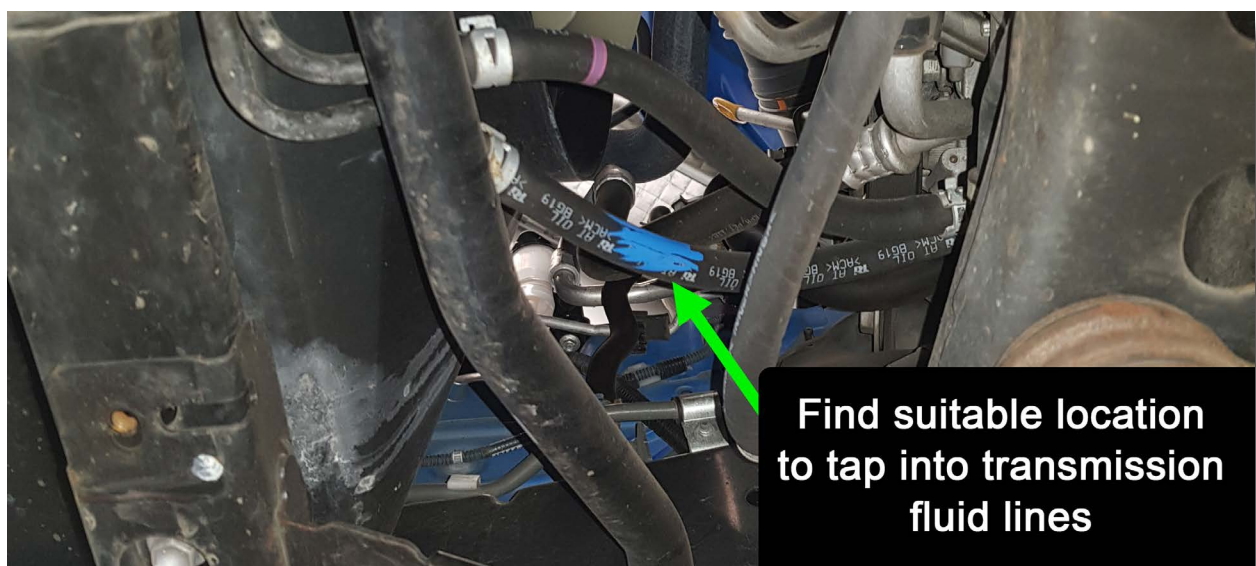

- 1.9. Route the cooler line hose to the tap in location. Secure the cooler line hose with cable ties to avoid hot or moving parts.
- 1.10. If possible, have the fluid run through any OEM cooling system and then through supplied cooler assembly. While this is not always possible, it is our preferred way of routing the fluid.

Below is an example of how to route the fluid in a vehicle with a OEM Radiator connection and an OEM external cooler. We have added the dual cooler assembly after the two OEM systems.

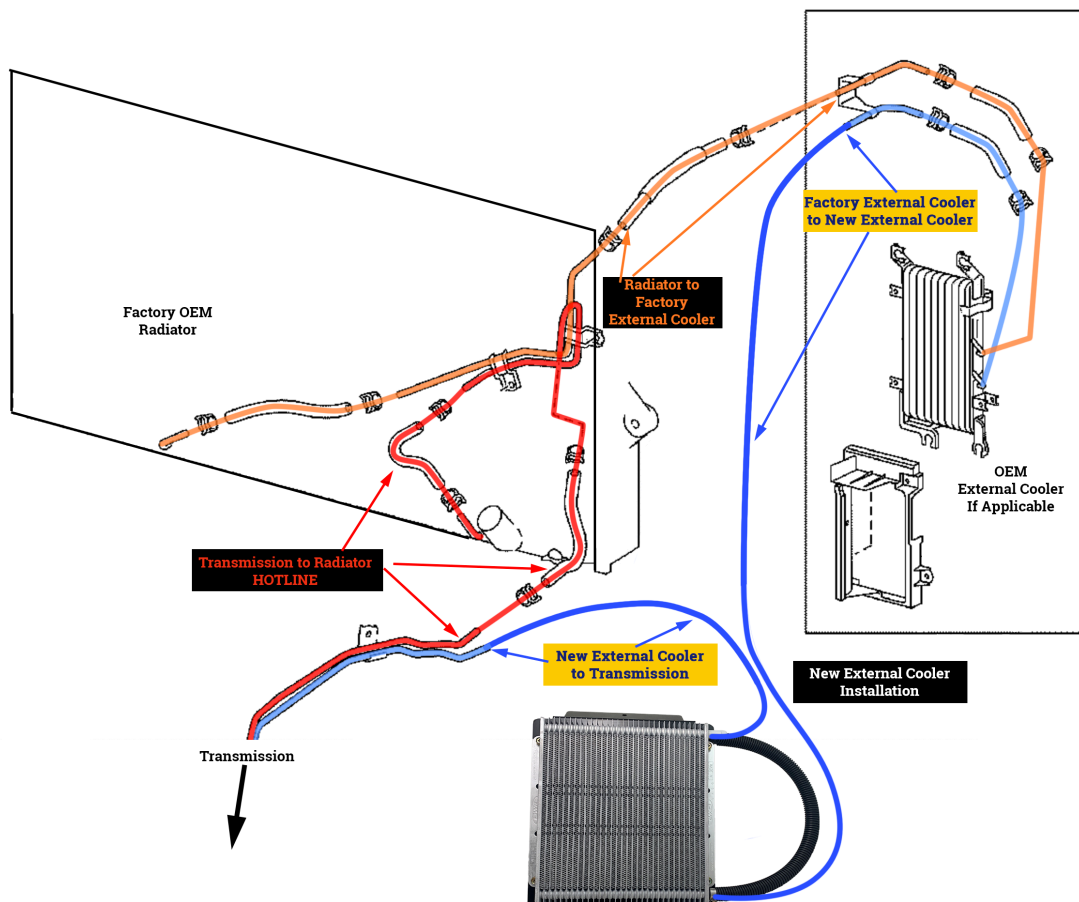

- 1.11. Cut and fit cooler line hoses to the OEM cooler connections using supplied hose clamps.
- 1.12. Re-check all hose clamps on hose connections are tight
- 1.13. Reinstall any removed bash plates or shrouds

2. Transmission Fluid Level Checks

- 2.1. During the process of fitting the Dual Cooler assembly, you may have lost some transmission fluid, plus the additional capacity of the cooler assembly itself. It is extremely important that you now check the level of the transmission fluid prior to driving the vehicle to prevent transmission failure. Depending on your transmission manufacturer they will generally use one of the following ways to check the fluid level.

Also ensure that you use transmission fluid that meets the required transmission fluid specification as defined by the transmission manufacturer.

2.1.1 Filler Tube and Dipstick.

Usually located in the engine bay

The filler tube and dipstick types are generally used on older vehicles (pre 2005). However, some new vehicles use a smaller version of this idea by having a mini filler hole with a dipstick located just above the pan.

With the engine bay filler tubes, you will need to allow a few minutes after adding fluid to check the level as you need to wait for the fluid to run all the way down to the bottom of the filler tube otherwise you may get a false reading.

Mini dipstick on side of transmission

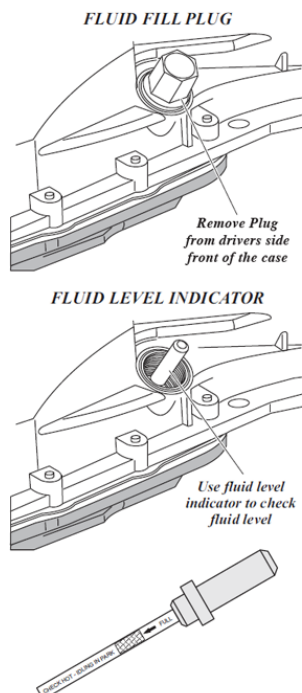

Engine bay filler tube & dipstick



2.1.2 Check Valve/Tube

Located in the transmission pan

For many later model vehicles, the manufacturer turned to a Check Tube that was welded to the inside of the pan that provided the set height for the transmission fluid at the top of the tube.

A bolt labeled 'Check' is usually located in the bottom of the tube underneath the transmission pan. There is also a large bolt located on the side of the transmission, usually half way up that is the fill location for adding transmission fluid.

With the engine running, you would undo the Check bolt and note what the fluid was doing.

No fluid coming out of hole	=	Fluid level is too low - add more fluid
Fluid flowing out quickly	=	Too much fluid - let it drain
Fluid dribbling out slowly	=	Correct level - Re-Install Check bolt.

Fluid level on a 'Check/Overflow Tube' style transmission

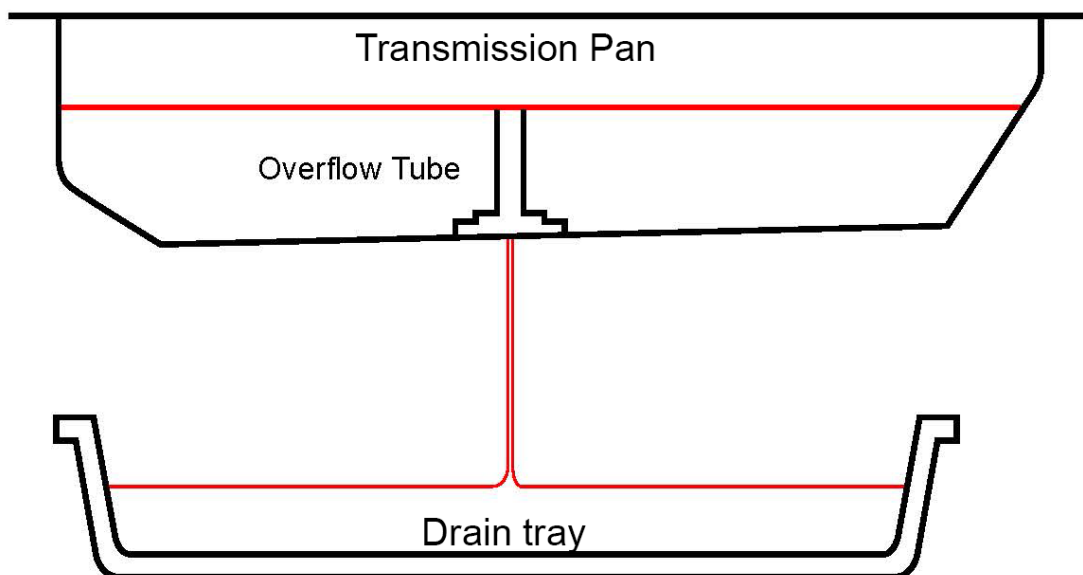

2.1.3 Check Bolt

Usually on side of Transmission

Very similar to Check Valve/Tube however these are usually located on the side of the transmission and function as both filler hole and fluid level check.

With the engine running, you would undo the Check bolt and note the fluid flow.

No fluid coming out of hole	=	Fluid level is too low - needs more fluid
Fluid flowing out quickly	=	Too much fluid - let it drain
Fluid dribbling out slowly	=	Correct level - Re-Install Check bolt.

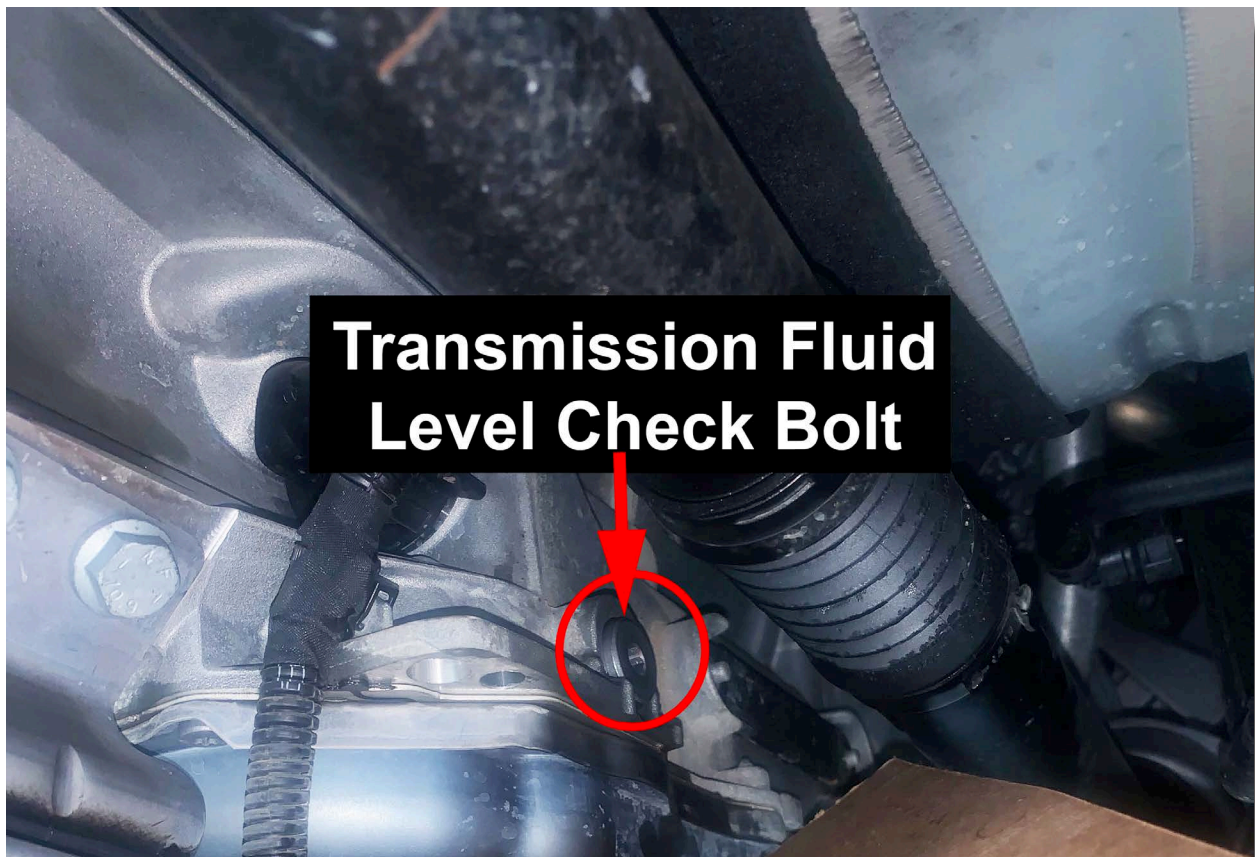

3. Test Drive and Recheck Fluid Level

- 3.1. Take vehicle for a road test for at least 15 minutes to get transmission fluid warm.
- 3.2. After returning from test drive leave engine running and check for any fluid leaks from the connections. You may need to tighten the hose clamps.
- 3.3. Re-check the transmission fluid level again to ensure that the fluid is at the correct level. It's possible there was an air pocket in the system that has now been cleared from driving which will show the fluid lower than it should be. Top up as required.
- 3.4. Clean up all transmission fluid and re-install any bash plates, shrouds or grille parts removed during installation.

This completes the installation of the Generic Dual External Transmission Oil Cooler Kit

Please remember ALL automatic transmissions have a service interval of 2 years or 40,000km to improve the longevity of the transmission.

Please Provide us with Feedback

If you have a minute to provide us with some feedback about your experience with Wholesale Automatic Transmissions and our products, that would be greatly appreciated.

Using your smart phone or device's camera app, point at the QR code below to take you straight to our feedback page for you to choose the most appropriate feedback method.

